

a--1

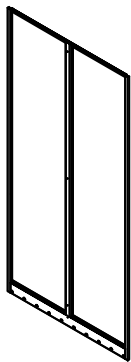

b--1



c--1



d--1

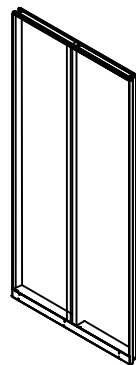

e--1

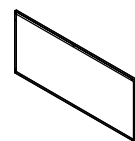

f--1

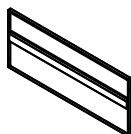

g--1



h--1

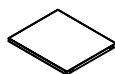

h1--1

i--25



M5

n--36



M4

k--6

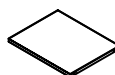

h2--1

j--2

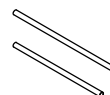

L--1

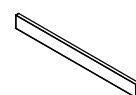

1.

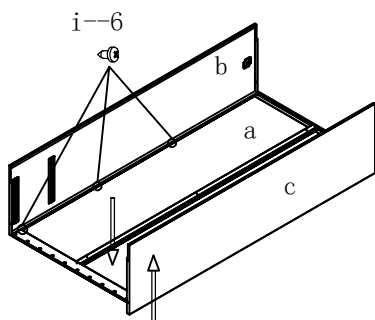

2.

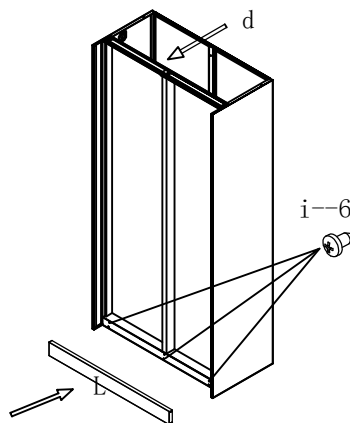

3.

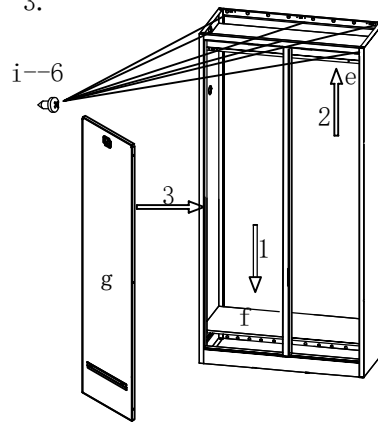

4.

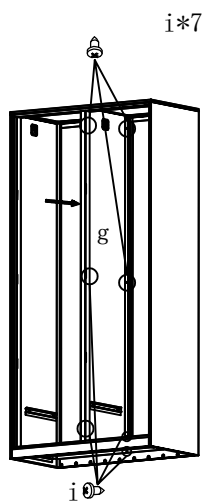

5.

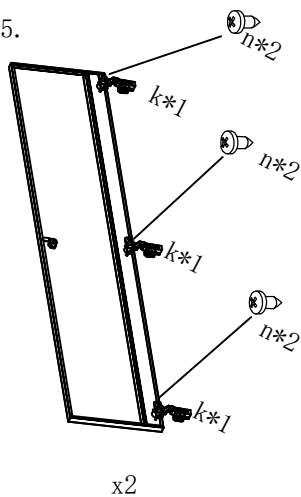

6.

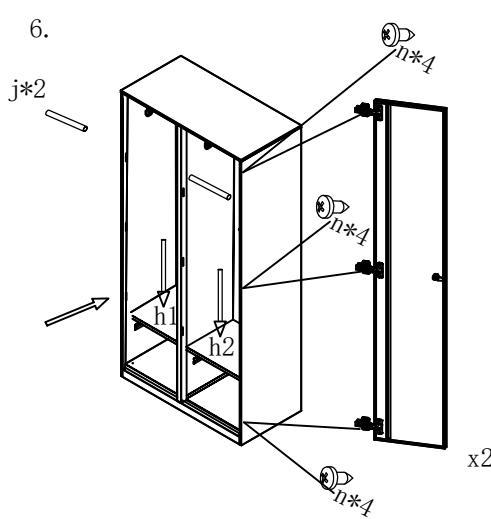

7.

