

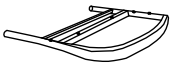









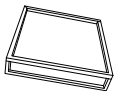

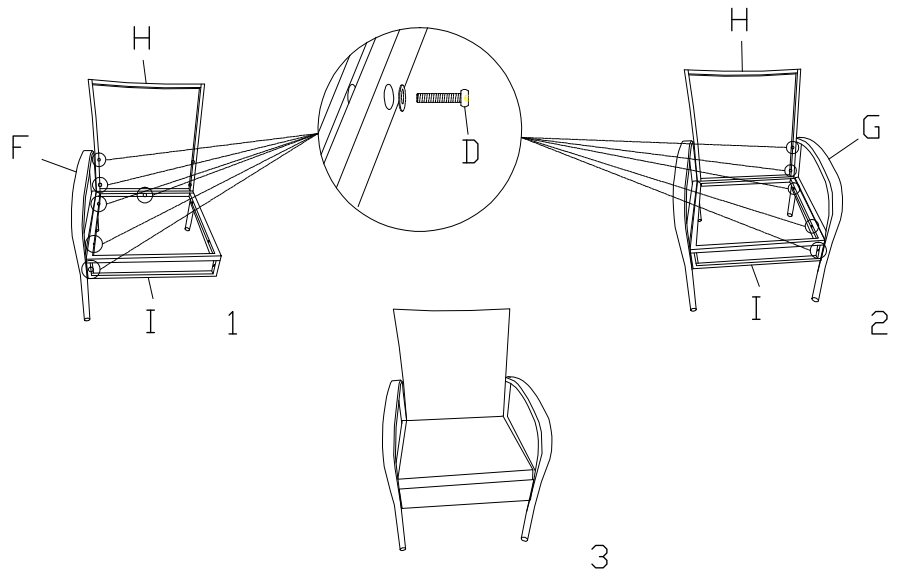

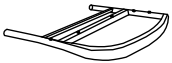
F		2X
G		2X
H		2X
I		2X
D	 M6*35	22X
E		1X

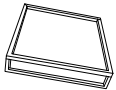

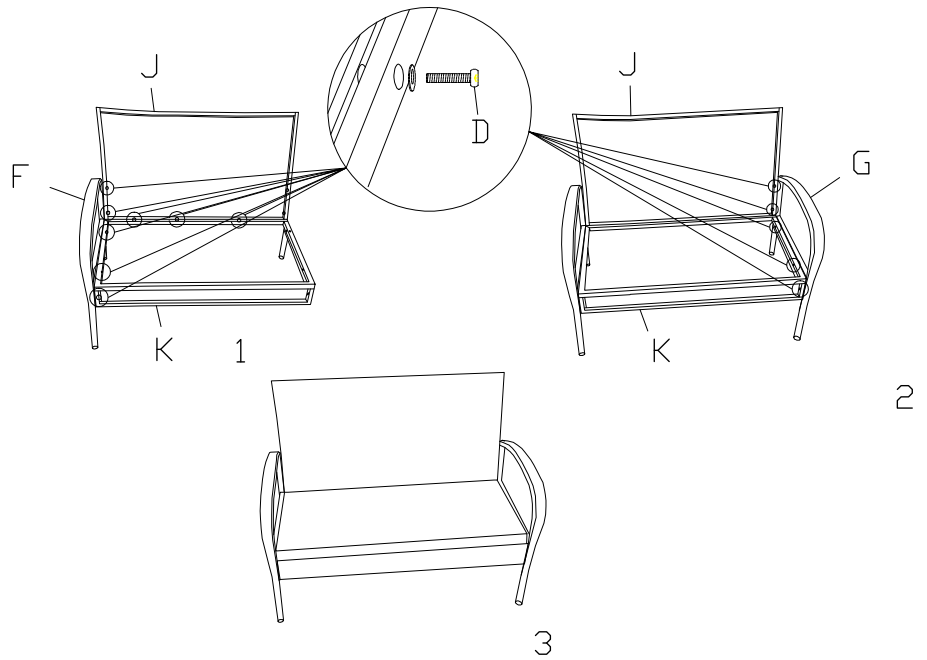
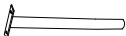
F		1X
G		1X
J		1X
K		1X
D	 M6*35	13X
E		1X



A		4X
B		1X
C		1X
D	 M6*15	8X
E		1X

