

TŁUMACZENIE INSTRUKCJI PRODUKTU

Wymiar : D100 * Š60 * V40 (cm)



- Przed montażem trzeba przeczytać całą instrukcję.
- Za pomocą wykazu części trzeba sprawdzić, czy dostarczono wszystkiego jego części.
- Podczas montażu trzeba stosować odpowiednie okulary ochronne albo inne środki bezpieczeństwa.

CODE – KOD

QTY - ILOŚĆ

Qty

code

Qty

01



L:370 mm



2

02



L:267 mm



2

03



L:997 mm

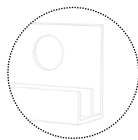

2

04



L:576.3 mm

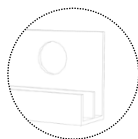

2

05



L:997 mm



1

06



L:993 mm

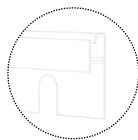

1

013

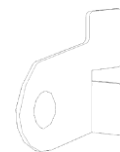

1

07A



L:587 mm

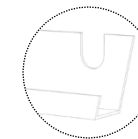

1

07B



L:587 mm



1

08



L:495 mm

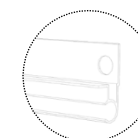

2

09

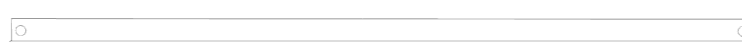

L:495 mm

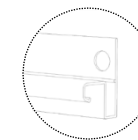

2

10



L:595 mm

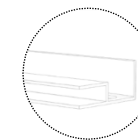

4

CODE – KOD

QTY - ILOŚĆ

Qty

code

Qty

014

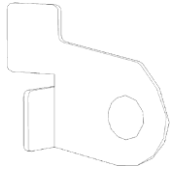

1

011



L:15 mm

2

012

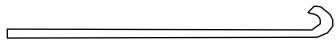

L:230mm

4

D1

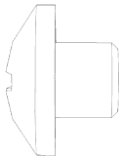

M6*6

25

D2

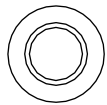

GB/T95-1985-6

25

D3

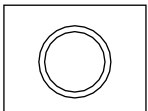

10*10*3-M6

25

A

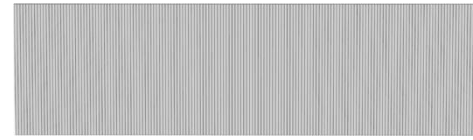

1

975x275x4mm

B

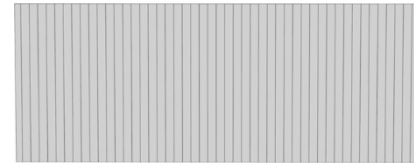

1

975x376x4mm

C

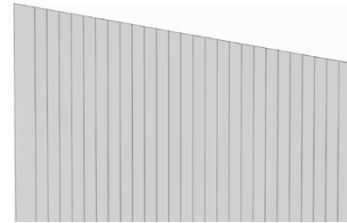

2

377x574.5x4mm





D

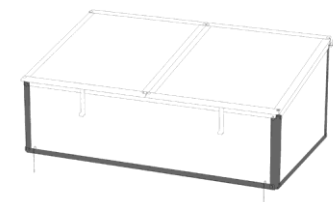

2

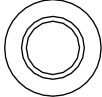
610x469x4 mm

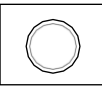

	x2		x16		x16
	x2		x16		
	x2		x2		

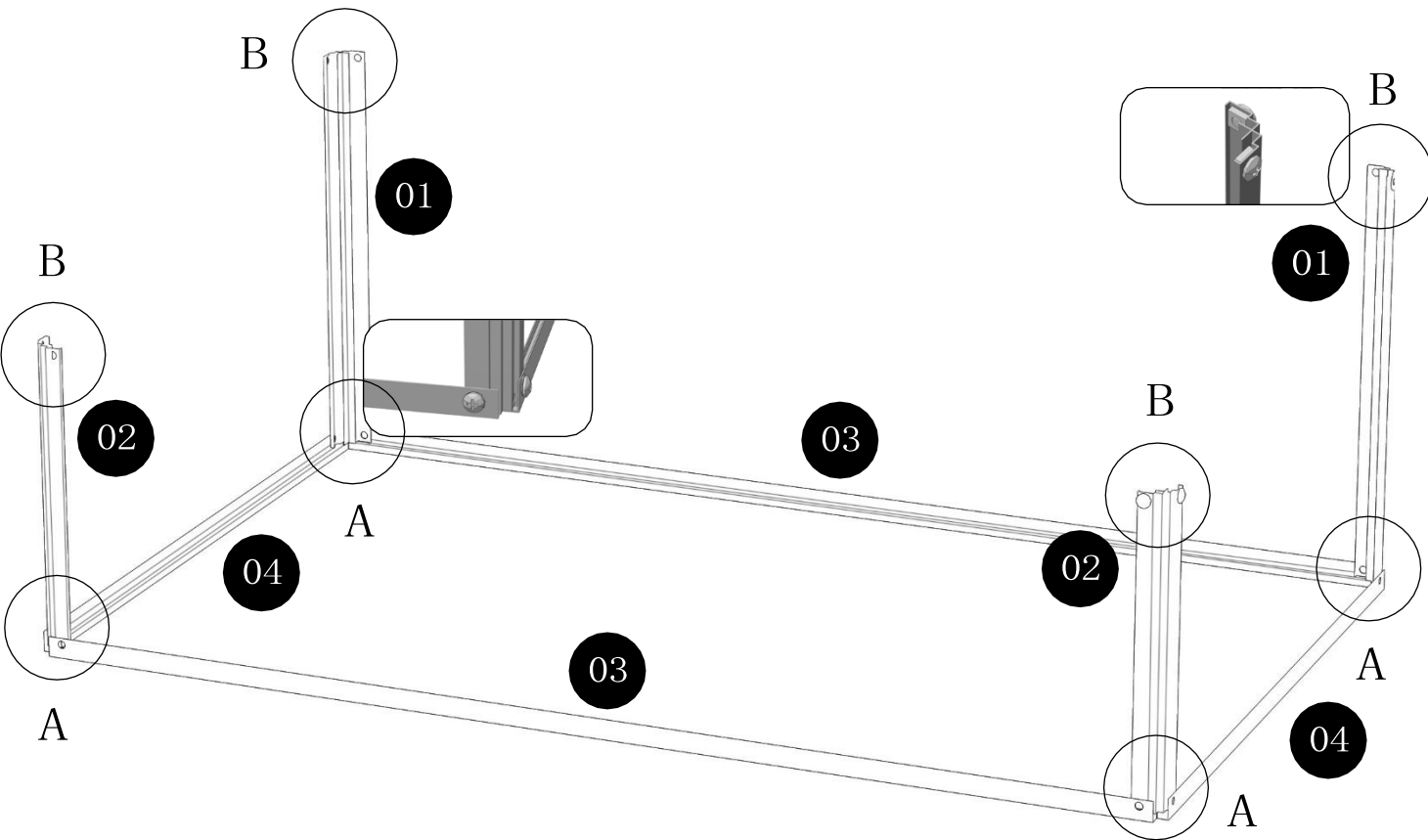

A

B

01

02

03

04

A

B

D1

D2

D3

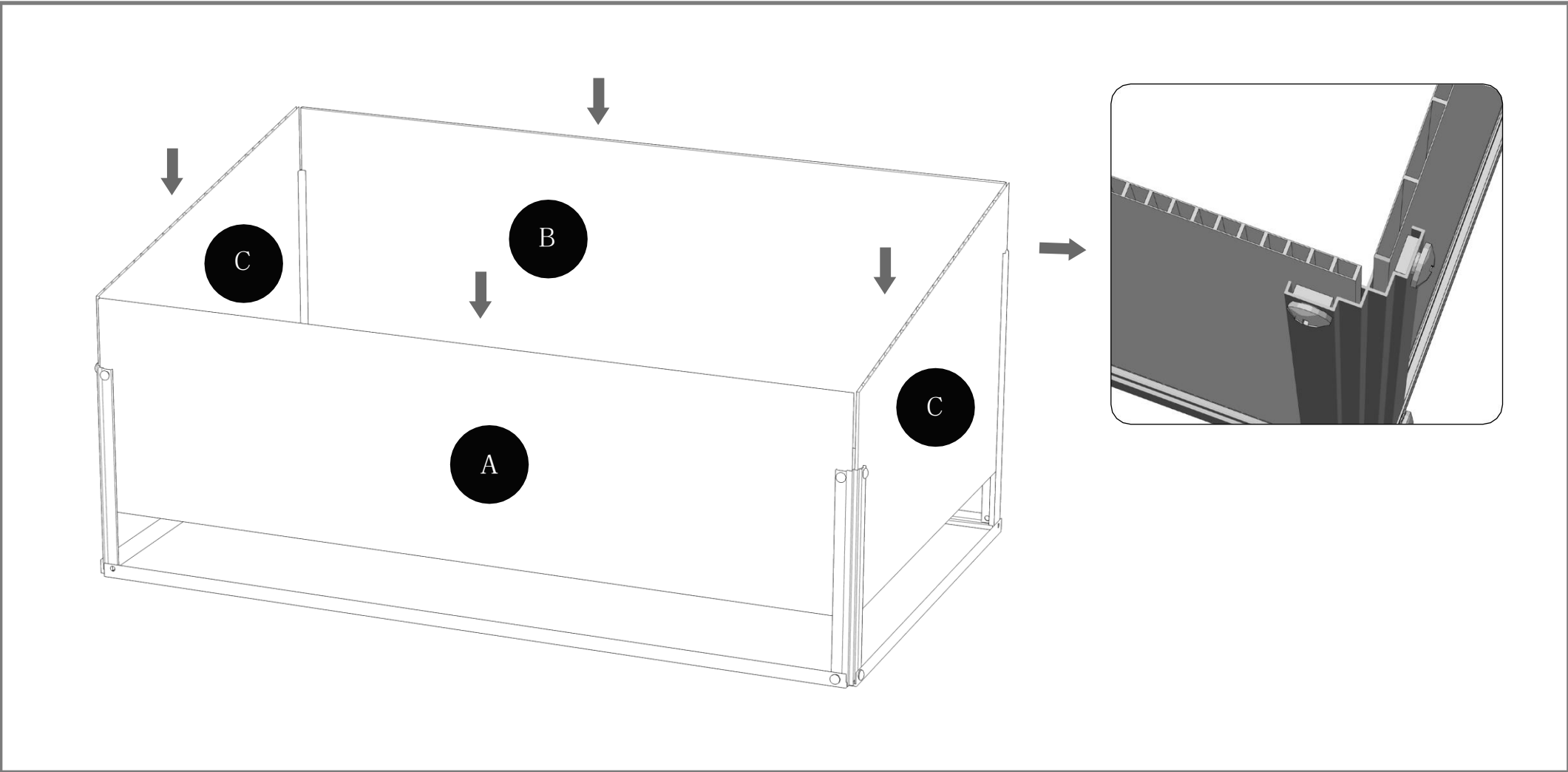
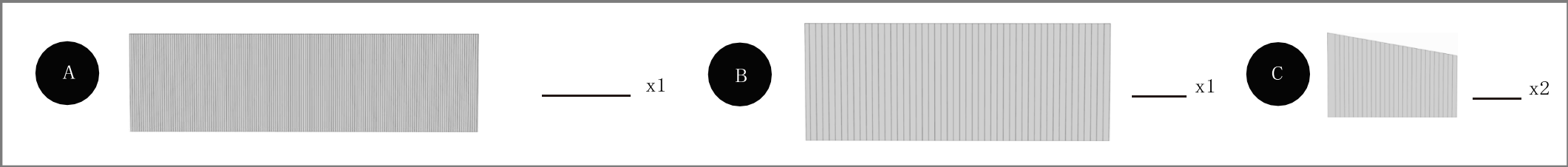
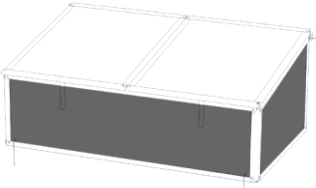

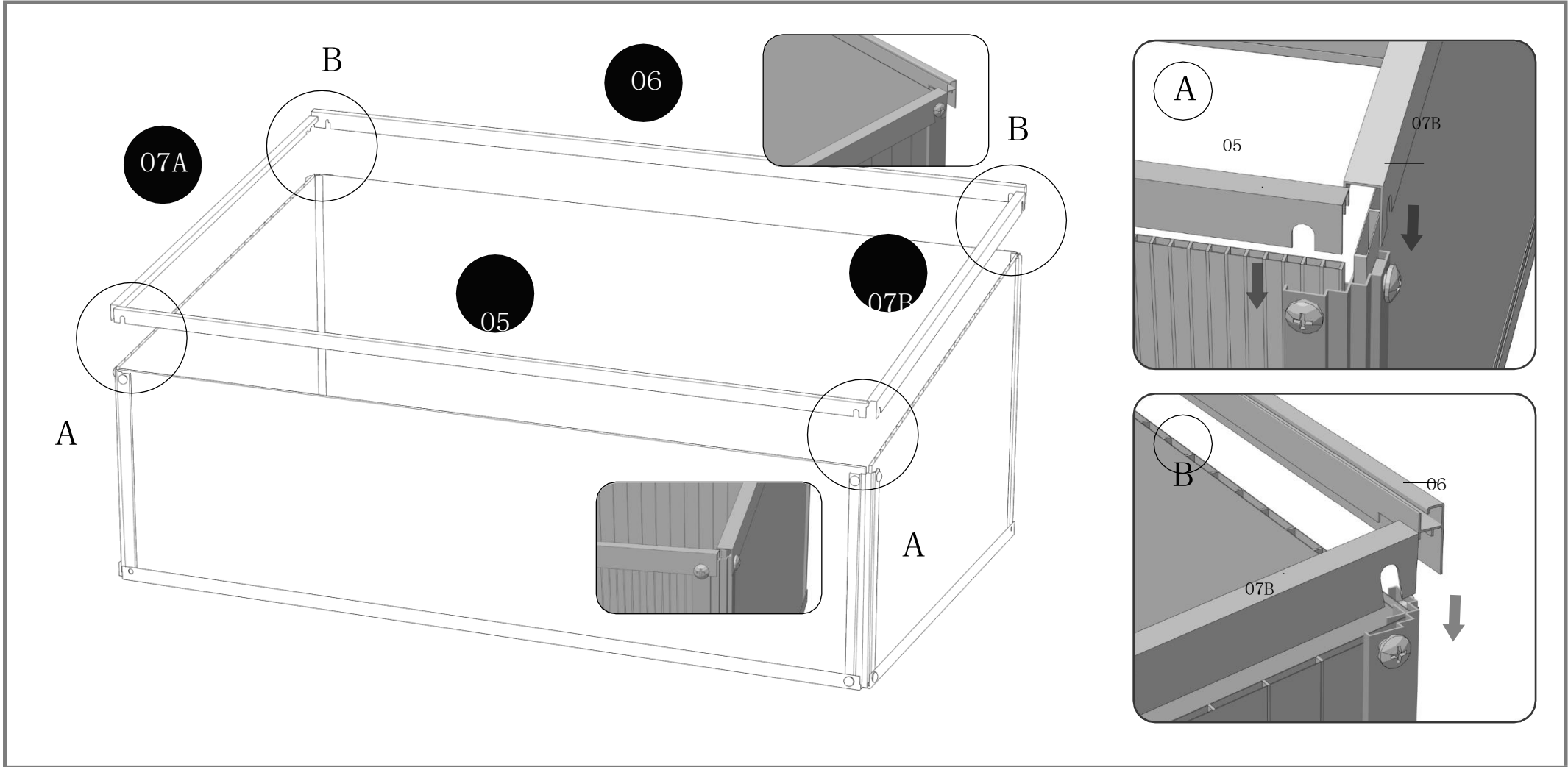
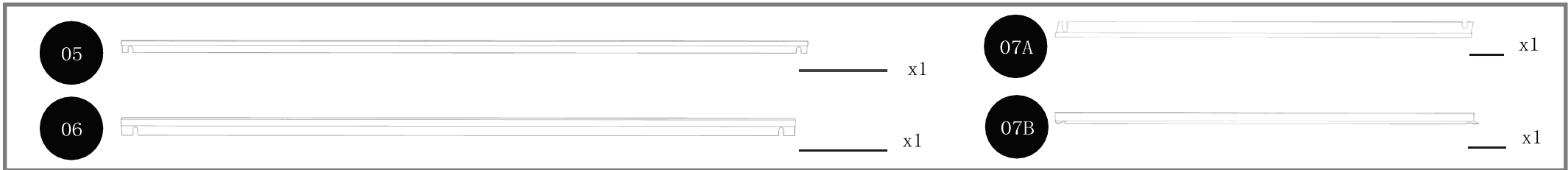
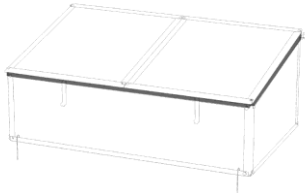

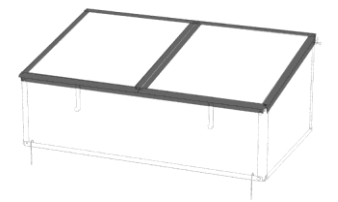

08		x2	D3		x8	D1		x8
09		x2	D		x2	D2		x8
10		x4						

make two covers

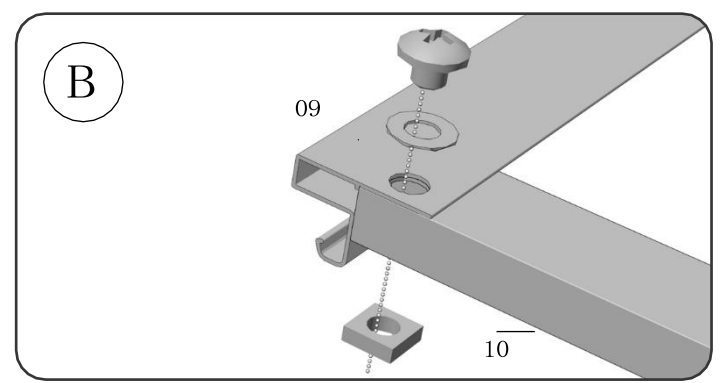
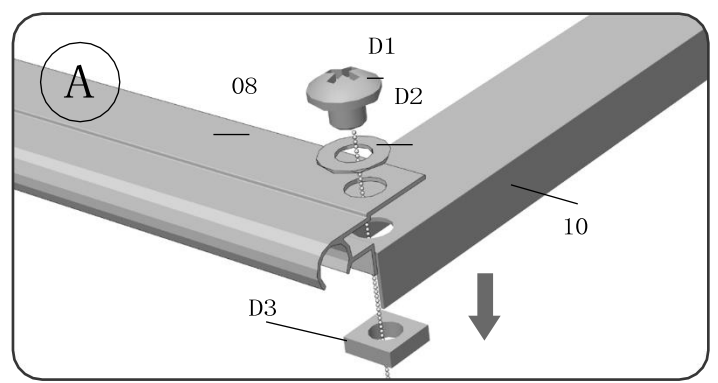
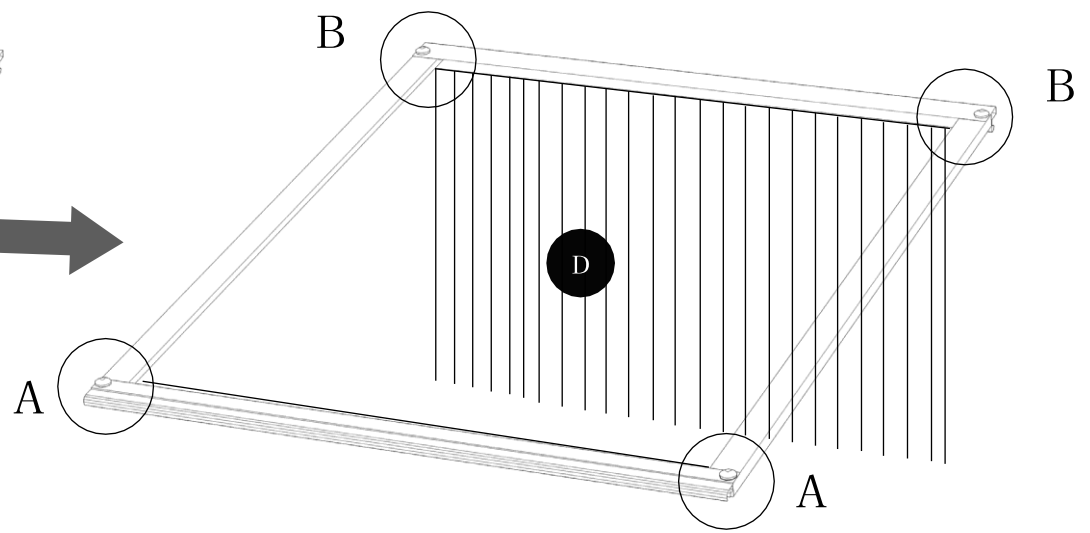
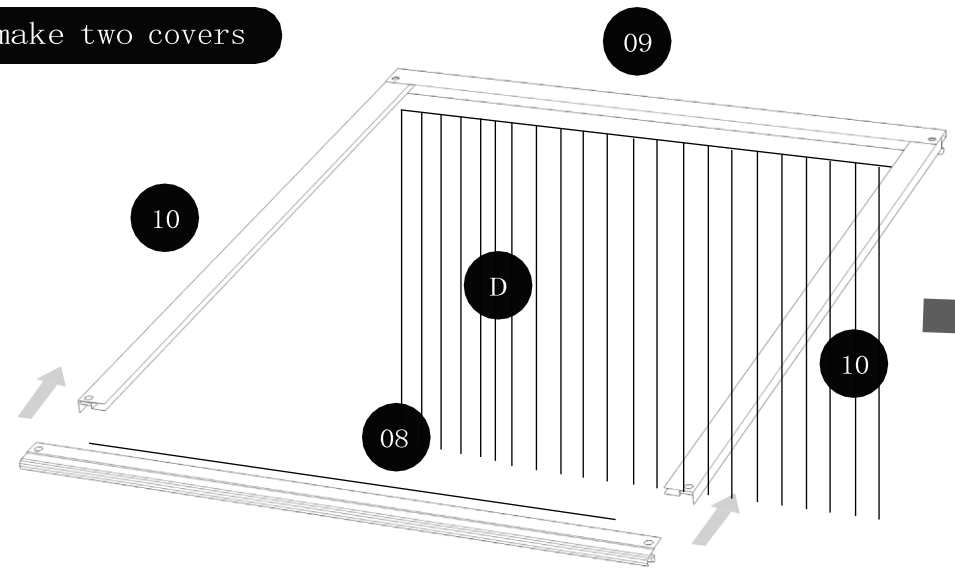

5

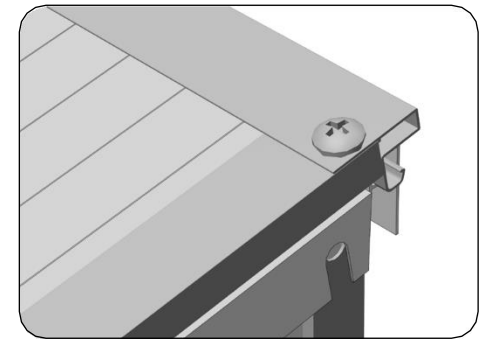
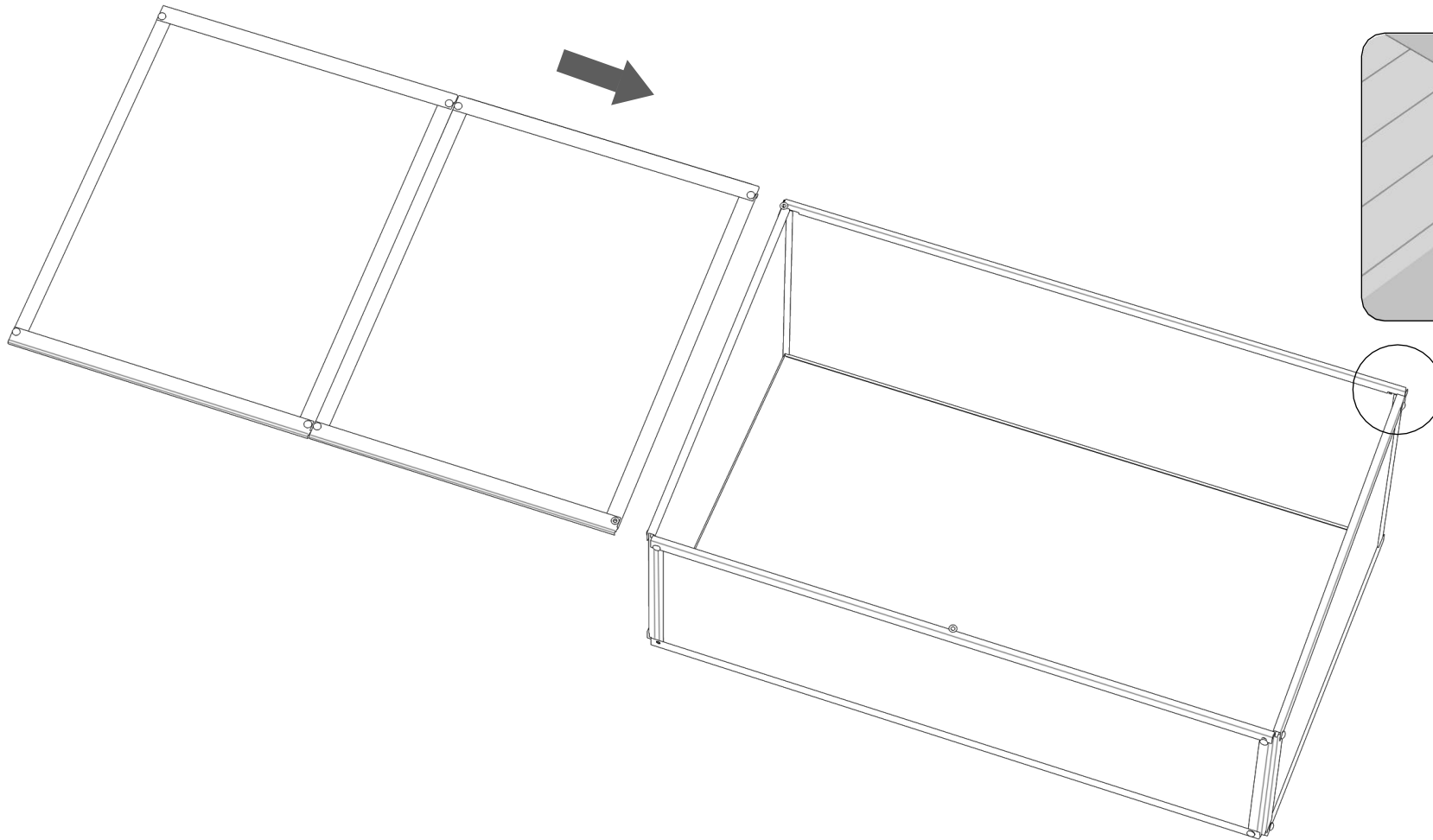
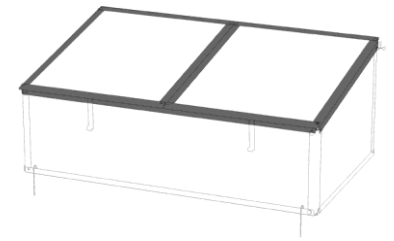

6

