

X2

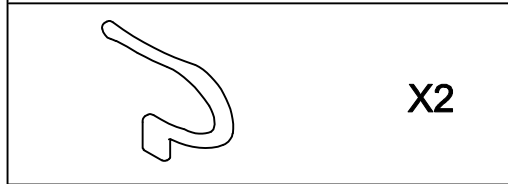

X2

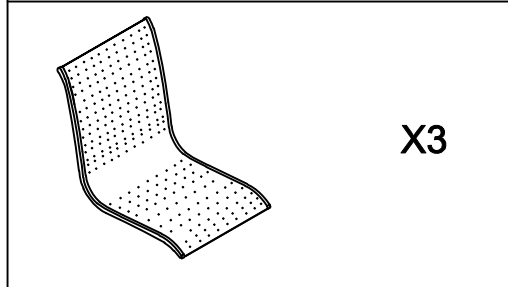

X3

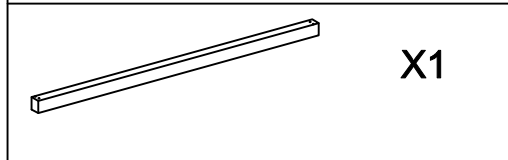

X1

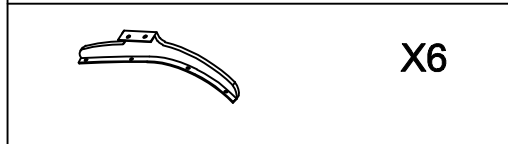

X6

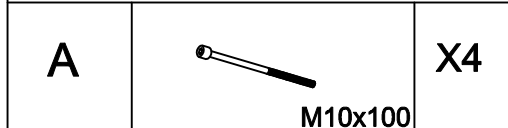

A

M10x100

X4



B

M8x12

X24



C

M8x16

X12



M10x120

X1



M8x85

X1

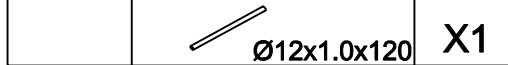

Ø12x1.0x120

X1

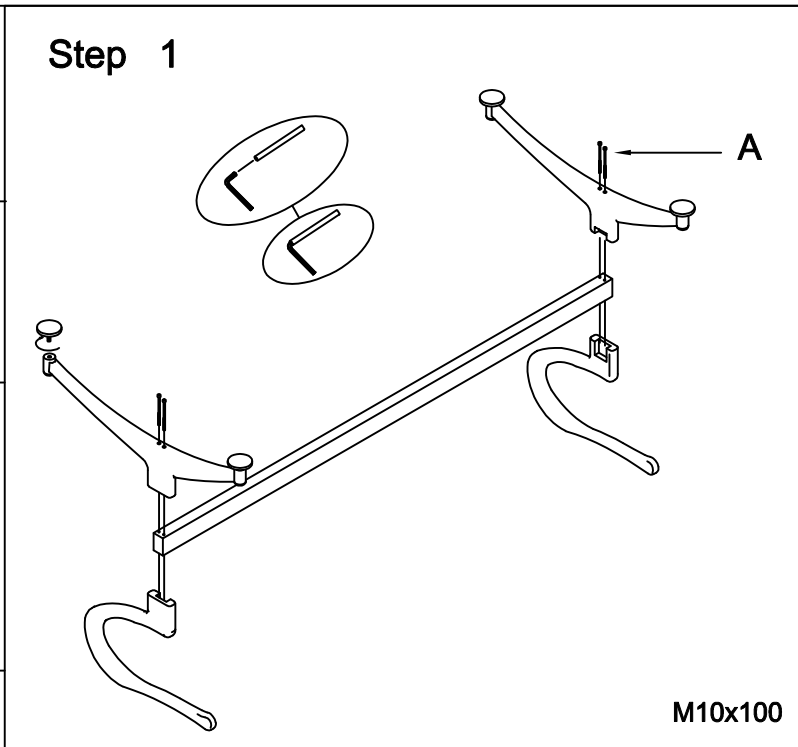

Step 1

M10x100

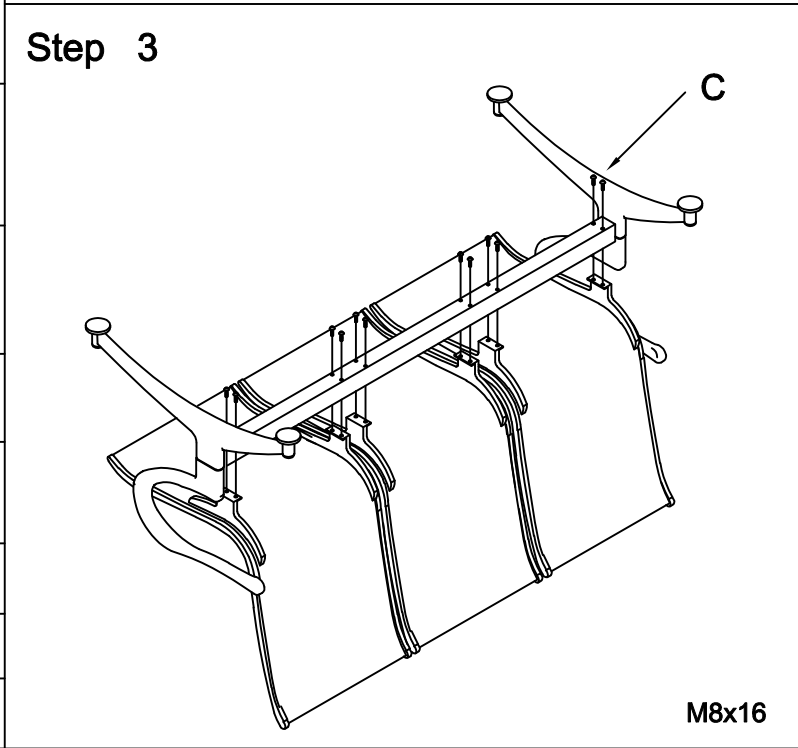

Step 3

M8x16

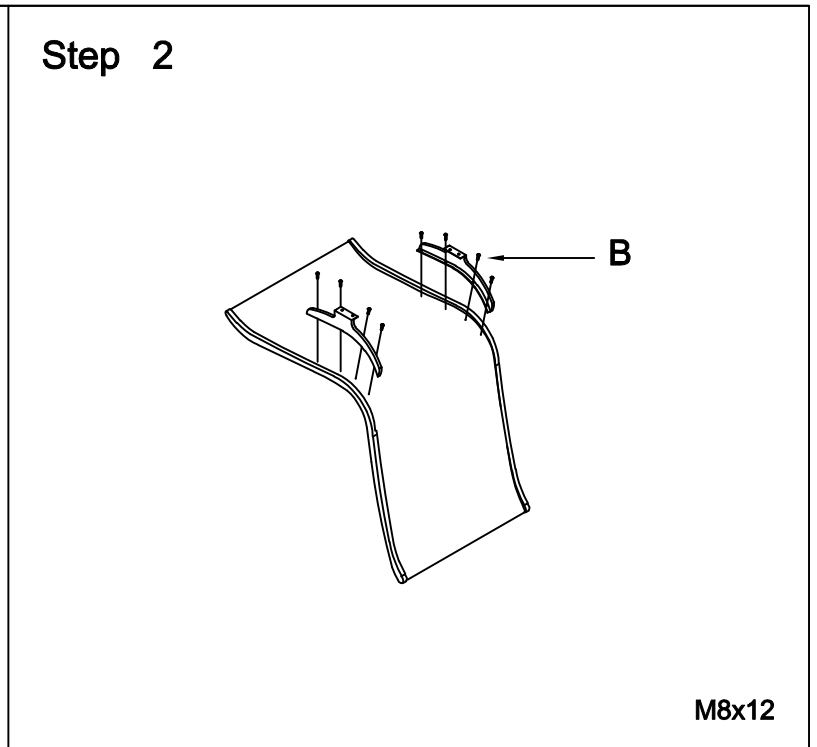

Step 2

M8x12

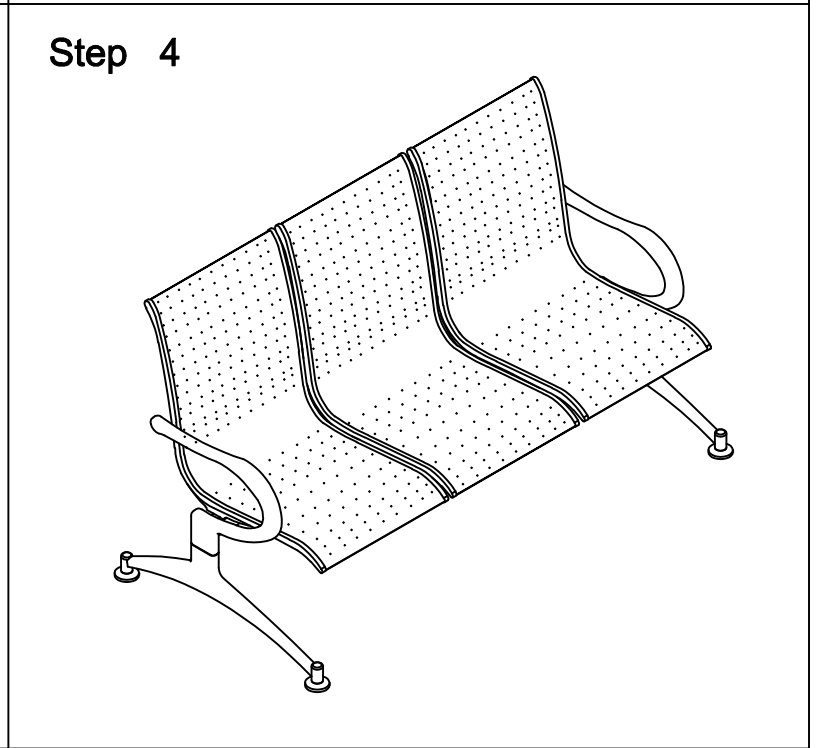

Step 4