

437277 - 437291

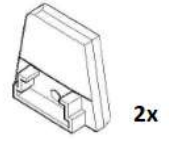

2x

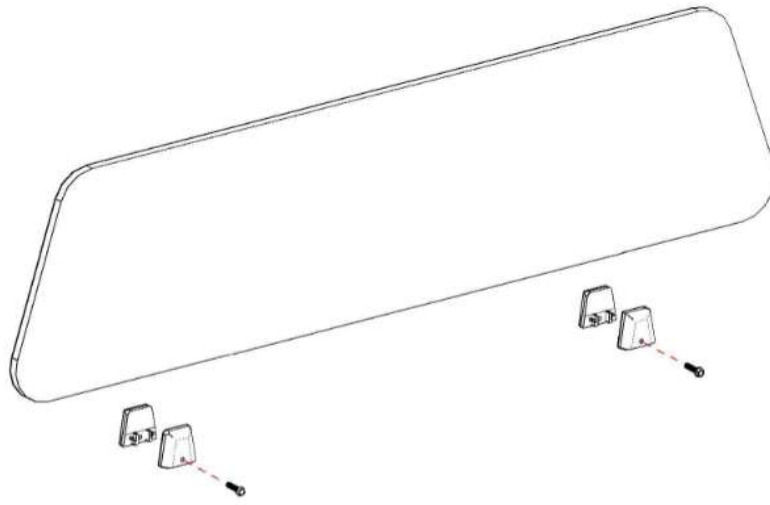

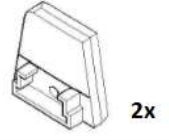

2x

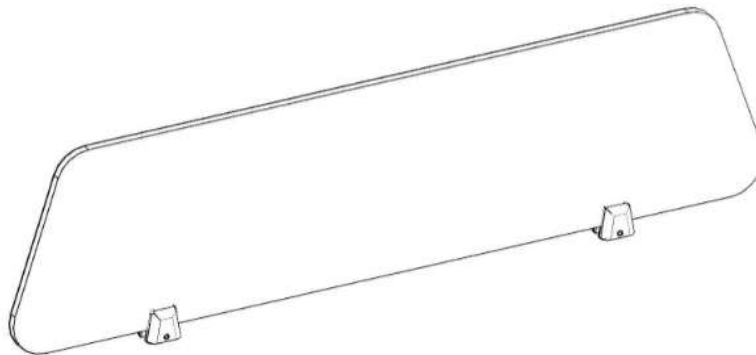

2x

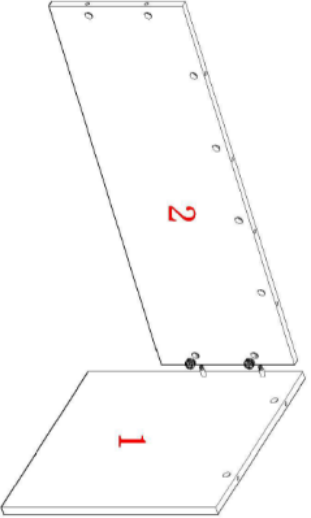
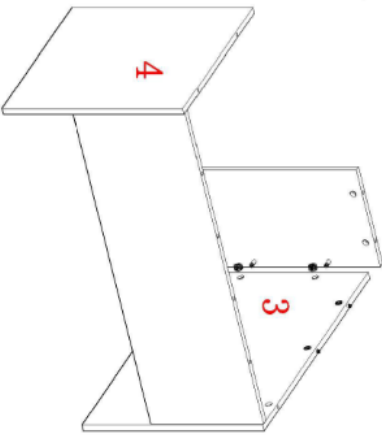

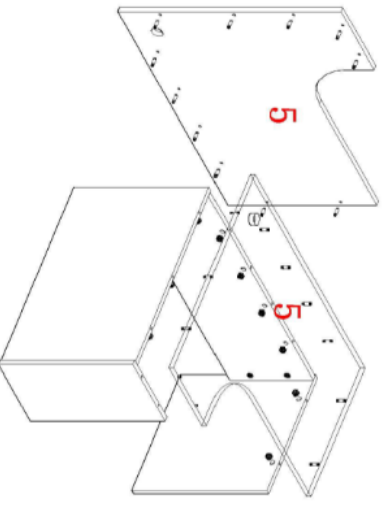
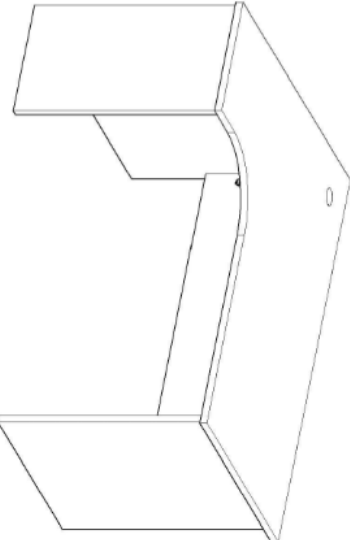



17ks 	a	I 	II 
17ks 	b	III 	IV 

16ks				
16ks				
4ks				
38ks				
4ks				
4ks				
4ks				
1ks				
2ks				

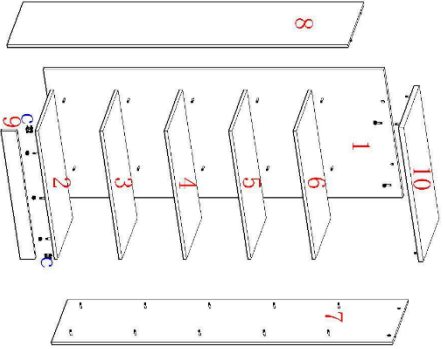
8ks		a	<b>I</b> 	
4ks		b		
1ks		c		
16ks		d		
			<b>II</b> 	

47ks	a					
47ks	b					
1ks	c					
8ks	d					
1ks	e					
66ks	f					
2ks	g	III				
4ks 4*20mm	h					
2ks	i					
1ks	j					

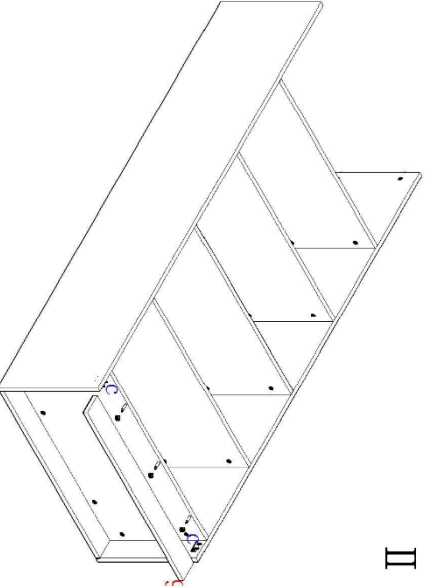
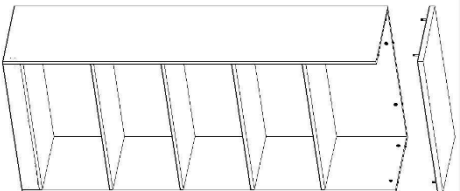
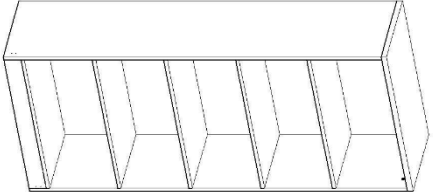
47ks	 <p>a</p>	 <p>I</p>	
47ks	 <p>b</p>		
2ks	 <p>c</p>		
8ks	 <p>d</p>		
	 <p>II</p>	 <p>III</p>	
			 <p>IV</p>

437262 - 437267

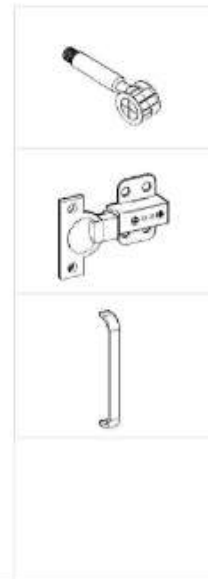
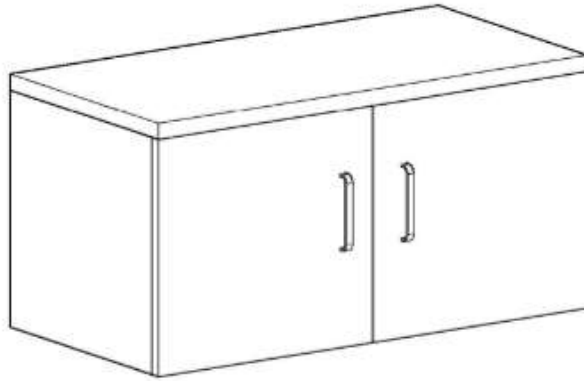

1

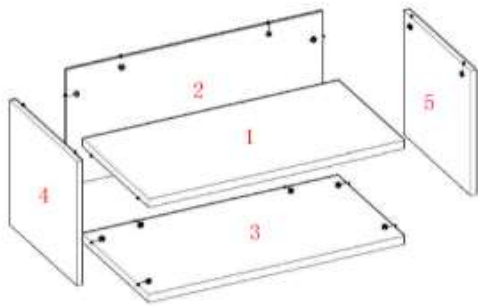

2

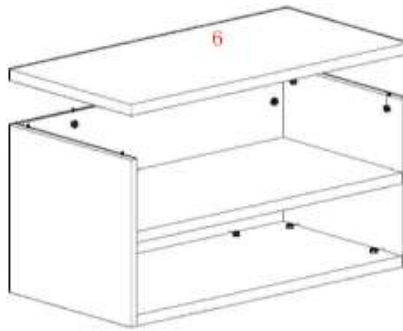

3

